

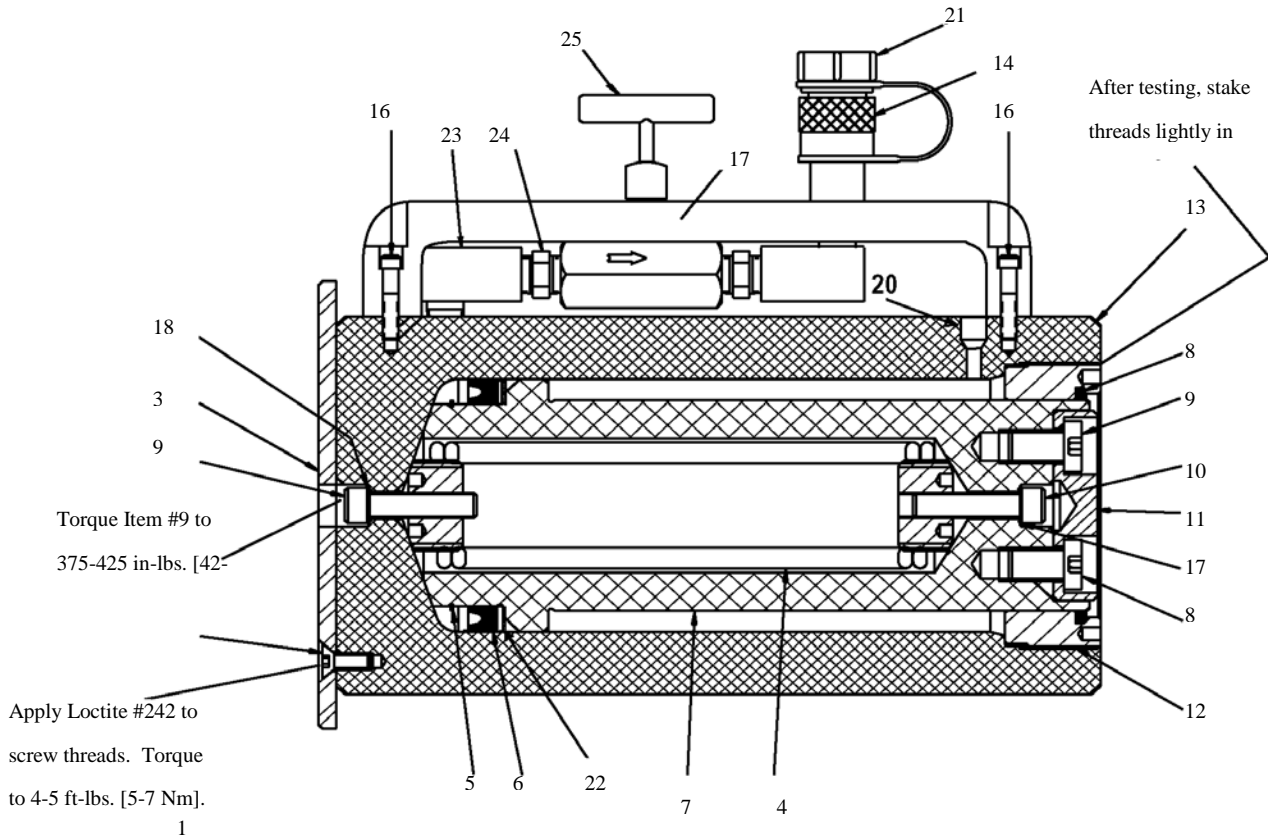

Repair Parts Sheet

55-Ton Aluminum Jack Model 10308



TO PROTECT YOUR WARRANTY, USE ONLY AW-32 HYDRAULIC OIL.



REPAIR PARTS LIST			
Item No.	10308	Qty.	Description
1	B1005028	7	Screw
3	S94692899	1	Base Plate
4	DA5078900	1	Spring Assembly
5	HL339044	1	Retaining Ring
6	HCH792041	1	U-Cup
7	DA4669040	1	Plunger
8	HG732044	1	Wiper Ring
9	L661028	2	Screw
10	B1076028	2	Cap Screw
11	U962127045	1	Saddle
12	Y193044	1	Stop Ring
13	DA4658030	1	Cylinder
14	10606	1	Coupler
16	B1013028	2	Socket Head Cap Screw
17	DA7162070	1	Handle
18	HB180167	2	Gasket
20	PA1203118	1	Filter
22	HDC1260566	1	Back-Up Ring
23	CJ641291	2	Street Elbow
24	CJ6510961	1	Pipe Nipple
25	V82	1	Needle Valve
* Indicates items included in and available only as part of Repair Kit RCA-502K.			





EQUIPMENT SUPPLY COMPANY

Instruction Sheet

Hydraulic Cylinders

L2241 Rev. O 08/97

IMPORTANT RECEIVING INSTRUCTIONS

Visually inspect all components for shipping damage. If any shipping damage is found, notify carrier at once. Shipping damage is NOT covered by warranty. The carrier is responsible for all repair or replacement cost resulting from damage in shipment.

SAFETY INFORMATION



WARNING

STAY CLEAR OF LOADS SUPPORTED BY HYDRAULICS.
A cylinder, when used as a load lifting device, should never be used as a load holding device. After the load has been raised, it should be blocked.



WARNING

DO NOT EXCEED EQUIPMENT RATINGS.

- Never attempt to lift a load weighing more than the capacity of the cylinder. Overloading causes equipment failure and possible personal injury.
- These cylinders are designed for a maximum pressure of 10,000 psi (700 bar). Do not connect these cylinders to a pump with a higher pressure rating.

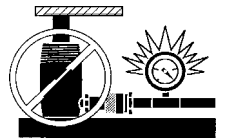

 **WARNING**

BE SURE SETUP IS STABLE BEFORE LIFTING LOAD.

- The cylinder should be placed on a flat surface that can support the load. Where applicable, use a cylinder base for added stability. Do not weld or otherwise modify the cylinder to attach a base or other support.
- Avoid situations where loads are not directly centered on the cylinder plunger. Off-center loads produce considerable strain on cylinders and plungers. In addition, the load may slip or fall, causing potentially dangerous results.
- Distribute the load evenly across the entire saddle surface. Tilt saddles are available to reduce offset loading (except 100 ton models). Always use a saddle to protect the plunger when threaded attachments are not used.



 **WARNING**

USE ONLY RIGID PIECES TO HOLD LOADS. Carefully select steel or wood blocks that are capable of supporting the load. Never use a hydraulic cylinder as a shim or spacer in any lifting or pressing application.

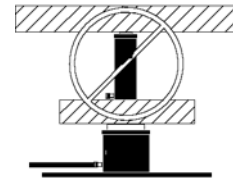

 **WARNING**

ONLY USE HYDRAULIC CYLINDER IN A COUPLED SYSTEM.

Never use a cylinder with unconnected couplers. If the cylinder becomes extremely overloaded, the coupler check ball and/or hydraulic oil may shoot out of the cylinder causing severe personal injury.



 **CAUTION**

AVOID DAMAGING HYDRAULIC HOSE.

- Avoid sharp bends and kinks when routing hydraulic hoses. Using a bent or kinked hose will cause severe back-pressure. Also, sharp bends and kinks will internally damage the hose leading to premature failure.

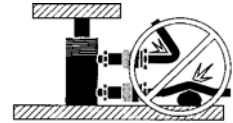

- Do not drop heavy objects on hose. A sharp impact may cause internal damage to hose wire strands. Applying pressure to a damaged hose may cause it to rupture.

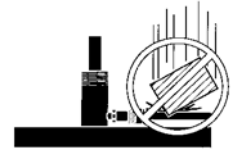

- Do not use the hydraulic hose to carry a hydraulic component (i.e. pumps, cylinders and valves).



 **CAUTION**

KEEP HYDRAULIC EQUIPMENT AWAY FROM FLAMES AND HEAT.

Excessive heat will soften packings and seals, resulting in fluid leaks. Heat also weakens hose materials and packings. For optimum performance **DO NOT** expose equipment to temperatures of 150°F (65°C) or higher. Protect hoses and cylinders from weld spatter.

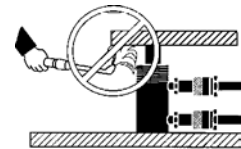

INSTALLATION

1. Make hydraulic connections. Use a pump with a release valve or a 3-way valve and one hose for single-acting cylinders (1). Use a pump with a 4-way valve and two hoses for double-acting cylinders (2).

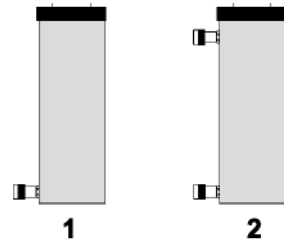

IMPORTANT: Double-acting cylinders must have both couplers connected.

Fully hand-tighten all couplers. Loose coupler connections will block the flow of oil between the pump and the cylinder.

2. Remove air from the cylinder as shown below.

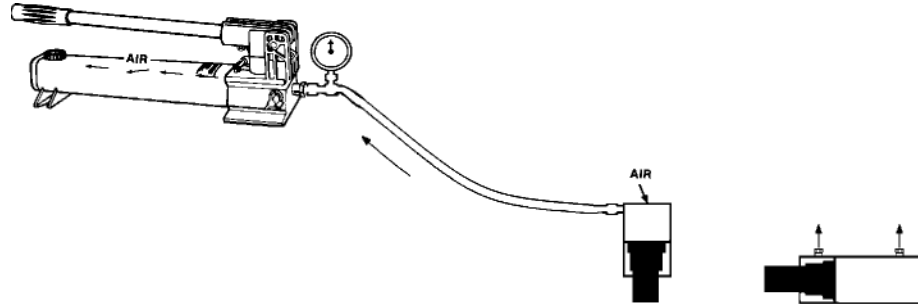

Single-acting cylinders: Position the cylinder so that the plunger is pointed down and the cylinder lower than the pump. Fully extend and retract the cylinder 2 or 3 times.

Double-acting cylinders: Lay the cylinder on its side and have the couplers facing up. Fully extend and retract the cylinder 2 or 3 times.

NOTE: Collar threads are rated for the full capacity of the cylinder when fully engaged in attachments.

NOTE: The use of cylinder attachments or extensions reduces the cylinder capacity by at least 50%.

OPERATION



DO NOT HANDLE PRESSURIZED HOSES. Escaping oil under pressure can penetrate the skin, causing serious injury. If oil is injected under the skin, see a doctor immediately.



Operate the hydraulic pump to advance and retract the cylinder.

Some single-acting cylinders are spring-return, others are load return. The speed of retraction is affected by the length of the hose and other restrictions in the line. Double-acting cylinders are powered in both directions by the pump.

The cylinder stop ring is designed to take the full load. However, to reduce cylinder wear, use less than full stroke when possible.

MAINTENANCE

1. Use dust caps when cylinders are disconnected from the hose. Keep entire cylinder clean to prolong cylinder life.
2. Store cylinders up-right to prevent seal distortion.

TROUBLE SHOOTING

These cylinders should be repaired only by Authorized ESCO Technical Service Centers. Single-acting cylinders are spring loaded and require special disassembly techniques to prevent personal injury.

PROBLEM	POSSIBLE CAUSES
Cylinder will not advance.	Pump release valve open.
	Coupler not fully tightened.
	Oil level in pump is low.
	Pump malfunctioning.
	Load is too heavy for cylinder.
Cylinder advances part way.	Oil level in pump is low.
	Coupler not fully tightened.
	Cylinder plunger binding.
Cylinder advances in spurts.	Air in hydraulic system.
	Cylinder plunger binding.
Cylinder advances slower than normal.	Leaking connection.
	Coupler not fully tightened.
	Pump malfunctioning.
Cylinder advances but will not hold.	Cylinder seals leaking.
	Pump malfunctioning.
	Leaking connection.
	Incorrect system set-up.
Cylinder leaks oil.	Worn or damaged seals.
	Internal cylinder damage.
	Loose connection.
Cylinder will not retract or retracts slower than normal.	Pump release valve is closed.
	Coupler not fully tightened.
	Pump reservoir over-filled.
	Narrow hose restricting flow.
	Broken or weak retraction spring.
	Cylinder damaged internally.
Oil leaking from external relief valve.	Coupler not fully tightened.
	Restriction in return line.



EQUIPMENT SUPPLY COMPANY

15270 Flight Path Drive • Brooksville, Florida 34609

Manufacturer of Equipment for Truck, Tractor, and Earth Mover Tire Changing



Phone 800/352-9852, 352/754-1117 • Fax 352/754-4508